

Fostex®

FULL RANGE SPEAKER UNIT

FE168EΣ

Features

- HP (Hyperbolic Paraboloid) shell diaphragm
- 'ES cone' paper made of banana plant's fiber
- UDR tangential edge / damper
- ø 120mm large ferrite magnet



Specifications

&

Thiele/Small Parameters

Size	:	160 mm / 6.5 in
Voice Coil Diameter	:	30 mm / 1.2 in
Cast / Stamped	:	Cast
Impedance	:	8 Ω
Reproduction Frequency Response	:	fs - 21 kHz
Sound Pressure Level	:	94.5 dB/W(m)
Rated Input	:	27 W
Music Power	:	80 W
Magnet Material	:	Ferrite
Magnet Weight	:	
(main)	:	721 g / 1.590 lb
(cancel)	:	g / lb
Net Weight	:	2,600 g / 5.732 lb

Frequency Response / Impedance

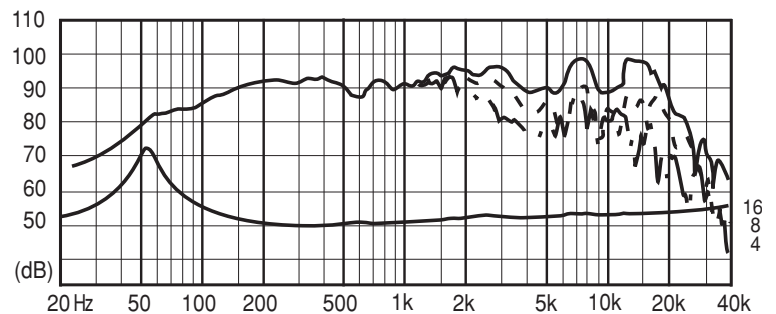

a	:	60 mm
D	:	106 mm
Sd	:	0.0113 m ²
Zn	:	8 Ω
Fs	:	51 Hz
Re	:	6.8 Ω
Le	:	0.056 mH
Qms	:	5.328
Qes	:	0.27
Qts	:	0.26
Mms	:	8.7 g
BL	:	8 Telsa/m
Vas	:	23.7 L
Xmax	:	1.6 mm
Eff/η0	:	0.9 %
Cms	:	1.278 mm/N
EBP	:	188.89

Dimensions & Mounting Information

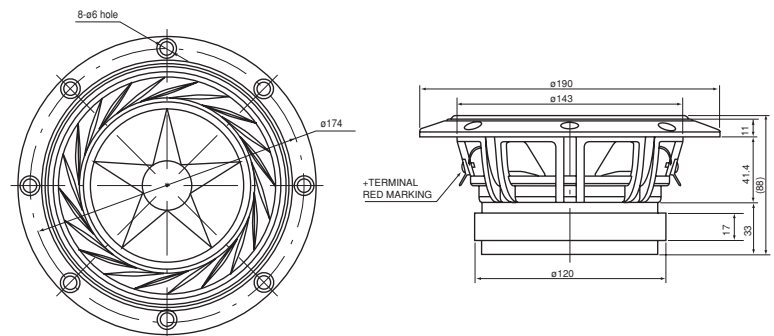

Overall Diameter	:	190 mm / 7.5 in
Baffle Hole Diameter	:	155 mm / 6.2 in
Depth	:	88 mm / 4.0 in